

IEG1-33295-2-V

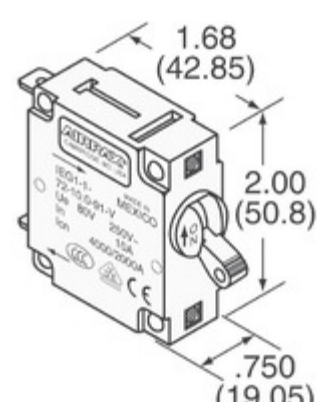

Obrázky jsou pouze orientační.
Podrobné informace o produktu naleznete v části Technické údaje produktu.

Koupit IEG1-33295-2-V s důvěrou od Component-World.HK, 1 rok záruka



Part Number: [IEG1-33295-2-V](#)

Výrobce: [Sensata Technologies, Airpax](#)

Popis: CIR BRKR MAG-HYDR LEVER

Datový list: [IEG, IUG, JEG, CEG, LEG Series Datasheet](#)

RoHS Status: Bez olova / V souladu RoHS

Ship From: Hong Kong

Shipment Way: DHL/Fedex/TNT/UPS/EMS

[Request For Quotation](#)

















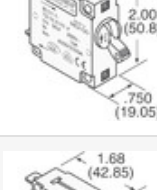
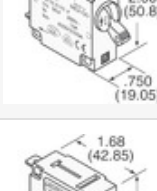
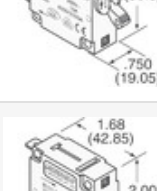

PARAMETR PRODUKTU

Part Number	IEG1-33295-2-V	Výrobce	Sensata Technologies, Airpax
Popis	CIR BRKR MAG-HYDR LEVER	Stav volného vedení / RoHS	Bez olova / V souladu RoHS
Dostupné množství	2507 pcs	Datový list	IAG,IUG,JEG,CEG,LEG Series Datasheet
Kategorie	Ochrana obvodu	Série	IEG
Počet pólů	1	Typ montáže	Panel Mount
Úroveň citlivosti na vlhkost (MSL)	1 (Unlimited)	Výrobní standardní doba výroby	6 Weeks
Stav volného vedení / RoHS	Lead free / RoHS Compliant	Osvětlení napětí (nominální)	-
Osvětlení	-	Jmenovitá hodnota proudu	-
Breaker Typ	Magnetic (Hydraulic Delay)	Pohon Type	Lever

Component-World.com je spolehlivý distributor elektronických součástek. Specializujeme se na všechny elektronické komponenty řady Sensata Technologies, Airpax. Máme 2507 kusy Sensata Technologies, Airpax IEG1-33295-2-V na skladě dostupných. Vyžádejte si citát z distributora součástí elektroniky na Component-World.com, náš prodejní tým vás bude kontaktovat do 24 hodin.

RFQ Email: info@Components-World.com

SOUVISEJÍCÍ PRODUKTY

	Část#: IEG1-33295-1-V Popis: CIR BRKR MAG-HYDR LEVER	Výrobci: Sensata Technologies, Airpax	Dotaz
	Část#: IEG1-33254-5-V Popis: CIR BRKR MAG-HYDR LEVER	Výrobci: Sensata Technologies, Airpax	Dotaz
	Část#: IEG1-34125-2-V Popis: CIR BRKR MAG-HYDR LEVER	Výrobci: Sensata Technologies, Airpax	Dotaz
	Část#: IEG1-32852-15-V Popis: CIR BRKR MAG-HYDR LEVER	Výrobci: Sensata Technologies, Airpax	Dotaz
	Část#: IEG1-32982-2-V Popis: CIR BRKR MAG-HYDR LEVER	Výrobci: Sensata Technologies, Airpax	Dotaz
	Část#: IEG1-33568-12R5-V Popis: CIR BRKR MAG-HYDR LEVER	Výrobci: Sensata Technologies/Airpax	Dotaz
	Část#: IEG1-33783-1-V Popis: CIR BRKR MAG-HYDR LEVER	Výrobci: Sensata Technologies, Airpax	Dotaz
	Část#: IEG1-33598-4-V Popis: CIR BRKR MAG-HYDR LEVER	Výrobci: Sensata Technologies, Airpax	Dotaz
	Část#: IEG1-32852-5-V Popis: CIR BRKR MAG-HYDR LEVER	Výrobci: Sensata Technologies, Airpax	Dotaz
	Část#: IEG1-33568-30-V Popis: CIR BRKR MAG-HYDR LEVER	Výrobci: Sensata Technologies, Airpax	Dotaz
	Část#: IEG1-32994-4-V Popis: CIR BRKR MAG-HYDR LEVER	Výrobci: Sensata Technologies, Airpax	Dotaz
	Část#: IEG1-32982-1-V Popis: CIR BRKR MAG-HYDR LEVER	Výrobci: Sensata Technologies, Airpax	Dotaz
	Část#: IEG1-32852-20-V Popis: CIR BRKR MAG-HYDR LEVER	Výrobci: Sensata Technologies, Airpax	Dotaz
	Část#: IEG1-33568-25-V Popis: CIR BRKR MAG-HYDR LEVER	Výrobci: Sensata Technologies, Airpax	Dotaz
	Část#: IEG1-34124-1-V Popis: CIR BRKR MAG-HYDR LEVER	Výrobci: Sensata Technologies, Airpax	Dotaz
	Část#: IEG1-34125-3-V Popis: CIR BRKR MAG-HYDR LEVER	Výrobci: Sensata Technologies, Airpax	Dotaz
	Část#: IEG1-34125-1-V Popis: CIR BRKR MAG-HYDR LEVER	Výrobci: Sensata Technologies, Airpax	Dotaz
	Část#: IEG1-33598-5-V Popis: CIR BRKR MAG-HYDR LEVER	Výrobci: Sensata Technologies, Airpax	Dotaz
	Část#: IEG1-33079-1-V Popis: CIR BRKR MAG-HYDR LEVER	Výrobci: Sensata Technologies, Airpax	Dotaz
	Část#: IEG1-33079-2-V Popis: CIR BRKR MAG-HYDR LEVER	Výrobci: Sensata Technologies, Airpax	Dotaz

Související klíčová slova pro IEG1-33295-2-V

Sensata Technologies, Airpax IEG1-33295-2-V.	IEG1-33295-2-V distributor	IEG1-33295-2-V dodavatel	IEG1-33295-2-V Cena
IEG1-33295-2-V Stáhnout datasheet.	IEG1-33295-2-V Datasheet.	IEG1-33295-2-V Stock.	koupit IEG1-33295-2-V.
Sensata Technologies, Airpax IEG1-33295-2-V.	Sensata Technologies/Airpax IEG1-33295-2-V.		